



# R8C/2A & 2B

# Product Guide

The R8C microcontroller family is the latest in a line of high performance microcontrollers from Renesas. The R8C/Tiny family is very suitable in offering more performance on applications in the 8-bit arena at an 8-bit price. The innovation on this chip is a 16-bit M16C core with an 8-bit bus. This makes it very easy to upgrade to the next step on the real 16-bit M16C devices. The R8C/2C & 2D are 80-pin devices with memory sizes from 48KByte up to 128KByte flash and has the same timer like the well know 52pin R8C/24-25, which can drive up to 8 x PWM and also includes support for 3-phase motor control with automatic dead time insertion.



## Contents:

- **Product overview**
  - Features, packages
  - advantages
- **Tools**
  - Starterkits
  - mid./high end Tools
  - free Software
- **Support - Contacts**

The R8C/2A-2B have the same powerful features like I2C, SPI, 2 x USART, dedicated LIN driver, three LVD levels and two internal high/low oscillators. New features like DA converters and more 16 Timers have been added. Their powerful multifunction Timers with a 40MHz clock source, can drive know up to 12 x 16bit PWM with different duty cycles. A dedicated Timer also allows the user to realize real time clock function. The internal 40MHz high speed oscillator has an excellent accuracy of +/-2% over the total temperature range and can be calibrated down to 1%. To make your system more reliable these devices includes different fail-safe functions like clock stop detection, special function register protection, data flash, watchdog

## R8C Key Features

- more performance in 8bit applications
- 16 bit CPU core – same as M16C
- 20MHz - 50ns min. instructions
- two internal oscillators (125KHz & 40MHz)
  - 40MHz with best accuracy
- low power consumption
- 20pin to 80pin packages
- 4Kbyte to 128kbyte Flash
- Power on reset & Low voltage detection
- On chip debugger

time, etc.. This helps to reduce costs in the next generations of small applications, white goods, industrial and security applications.

For applications which needs low power at high performance, the R8C consumes only 0.8µA or 2.2µA in STOP/WAIT mode. Therefore dedicated battery applications can be realized.



## Renesas Technology

*the world's number 1 provider of microcontrollers, takes you where your imagination leads*



# R8C/2A & 2B

# Product Guide

## Product overview

- **M16C CPU Core (16-bit)**
  - 20 MHz@ 3.0-5.5V
  - 10 MHz@ 2.7-5.5V
  - 5MHz@ 2.2V-5.5V
- **Clock generation circuit**
  - Main clock with Xin/Xout (up to 20MHz)
  - Low/High speed internal ring oscillator (125KHz/40MHz)
  - sub clock Xcin/Xcout (32kHz)
  - Main clock stop detect feature
- **Timers**
  - 8 Bit, Timers with prescaler (Timer A,B)..... 2ch
  - 8 Bit, Timer multi function (RE with RTC)..... 1ch
  - 16 Bit, Timer (Timer RD - capture compare). 2ch
  - 16 Bit, Timer (Timer RC - capture compare). 1ch
  - 16 Bit, Timer (Timer RF - capture compare). 1ch
  - Watchdog Timer with ring oscillator
- **Serial I/O**
  - USART..... 3ch
  - SSUA or I2C (master/slave)..... 1ch
  - LIN ..... 1ch
- **AD - converter** - 10bit (SH & sweep mode)..... 12ch
- **DA – converter** – 8bit..... 2ch
- **POR and LVD**
  - (3 levels:Vdet0=2.3V; Vdet1=2.85V; Vdet2 =3.6V)
- **I/O and Interrupts**
  - 55 I/O + 2 Input Only..... 57 pins
    - all IO ports have selectabel pull up resistors
  - HW-Interrupts: internal/external ..... 23/ 5
  - SW-Interrupts/ Prio. Levels .....4/ 7
- **Memory capacity**
  - 128k Bytes/ 7.5k Bytes
  - 96k Bytes/ 7k Bytes
  - 64k Bytes/ 3k Bytes
  - 48k Bytes/ 2.5k Bytes
  - 2x1k Bytes Data Flash (only R8C/2B)
- **Operation temperature**
  - N-version:* -20 °C to +85 °C
  - D-version:* -40 °C to +85 °C

Timer A (1ch, 8 bit)	RTC-Timer RE (1ch, 8 bit)	USART (async/Sync) 3 x ch
Timer B (1ch, 8-bit)	A/D (10-bit, 12 ch)	
Timer RC (1ch, 16-bit)	Timer RF (1ch, 16-bit)	DA (8-bit, 2 ch)
Timer RD (2ch, 16-bit)	Watchdog Timer (on/Off)	I2C or SSUA interface
On-chip debug	<b>M16C Core</b> 20 MHz@5V	POR/ LVD
RAM up to 7KB	Dataflash*1 2 x 1K block	Flash Memory 48,64,96KB
on chip osc. low speed (125KHz)	on chip osc. 40MHz	Main Clock up to 20MHz
55 I/O (8 w/ 20mA drive) + 2 Input Only		
	sub. clock 32kHz	Hardware LIN (via UART + Timer A)

\*1 only on R8C/2B

### Suitable Applications:

R8C/2C-2D is a general purpose device for ...

- **Electronic household appliances,**
- **Office equipment, audio equipment,**
- **Consumer equipment, etc.**
- **Motor control**

Due to his powerful Timer RD and RC with 40MHz, which are excellent features to realize high performance and cost sensitive motor control solutions.



# R8C/2A & 2B

# Product Guide

Group	Device	Package Type	Memory Size			Status
			Flash	RAM	Data Flash	
R8C/2A 0.5mm pin pitch	R5F212A7SNFP	PLQP0064KB-A	48K	2.5K	-	MP
	R5F212A8SNFP	PLQP0064KB-A	64K	3K	-	MP
	R5F212AASNFP	PLQP0064KB-A	96K	7K	-	MP
	R5F212ACSNFP	PLQP0064KB-A	128K	7K	-	MP
R8C/2B 0.5mm pin pitch	R5F212B7SNFP	PLQP0064KB-A	48K	2.5K	2 x 1K	MP
	R5F212B8SNFP	PLQP0064KB-A	64K	3K	2 x 1K	MP
	R5F212BASNFP	PLQP0064KB-A	96K	7K	2 x 1K	MP
	R5F212BCSNFP	PLQP0064KB-A	128K	7K	2 x 1K	MP
R8C/2A <b>D-version</b> 0.5mm pin pitch	R5F212A7SDFP	PLQP0064KB-A	48K	2.5K	-	MP
	R5F212A8SDFP	PLQP0064KB-A	64K	3K	-	MP
	R5F212AASDFP	PLQP0064KB-A	96K	7K	-	MP
	R5F212BCSDFP	PLQP0064KB-A	128K	7K	-	MP
R8C/2B <b>D-version</b> 0.5mm pin pitch	R5F212B7SDFP	PLQP0064KB-A	48K	2.5K	2 x 1K	MP
	R5F212B8SDFP	PLQP0064KB-A	64K	3K	2 x 1K	MP
	R5F212BASDFP	PLQP0064KB-A	96K	7K	2 x 1K	MP
	R5F212BCSDFP	PLQP0064KB-A	128K	7K	2 x 1K	MP
R8C/2A 0.8mm pin pitch	R5F212A7SNFA	PLQP0064GA-A	48K	2.5K	-	MP
	R5F212A8SNFA	PLQP0064GA-A	64K	3K	-	MP
	R5F212AASNFA	PLQP0064GA-A	96K	7K	-	MP
	R5F212ACSNFA	PLQP0064GA-A	128K	7K	-	MP
R8C/2B 0.8mm pin Pitch	R5F212B7SNFA	PLQP0064GA-A	48K	2.5K	2 x 1K	MP
	R5F212B8SNFA	PLQP0064GA-A	64K	3K	2 x 1K	MP
	R5F212BASNFA	PLQP0064GA-A	96K	7K	2 x 1K	MP
	R5F212BCSNFA	PLQP0064GA-A	128K	7K	2 x 1K	MP
R8C/2A <b>D-version</b> 0.8mm pin Pitch	R5F212A7SDFA	PLQP0064GA-A	48K	2.5K	-	MP
	R5F212A8SDFA	PLQP0064GA-A	64K	3K	-	MP
	R5F212AASDFA	PLQP0064GA-A	96K	7K	-	MP
	R5F212ACSDFA	PLQP0064GA-A	128K	7K	-	MP
R8C/2B <b>D-version</b> 0.8mm pin pitch	R5F212B7SDFA	PLQP0064GA-A	48K	2.5K	2 x 1K	MP
	R5F212B8SDFA	PLQP0064GA-A	64K	3K	2 x 1K	MP
	R5F212BASDFA	PLQP0064GA-A	96K	7K	2 x 1K	MP
	R5F212BCSDFA	PLQP0064GA-A	128K	7K	2 x 1K	MP



**64pin LQFP**  
10 x 10 x 1.7mm  
0.5mm pitch



**64pin LQFP**  
14 x 14 x 1.7mm  
0.8mm pitch

**Operation temperature**  
N-version: -20 °C to +85 °C  
D-version: -40 °C to +85 °C



# R8C/2A & 2B

*the best choice...*

## Key points:

- **40MHz internal oscillator**
  - excellent tolerance on total temperature range -40 °C to 85 °C
  - adjustable to 1% via software
- **suitable for 3phase motor control**
  - dedicated 16bit Timer RD – with 40MHz internal oscillator
- **high performance 16bit Timer RC and Time RD**
  - with a lot of powerful timer modes
  - can drive up to 12 x 16bit PWM
  - fail safe function - cut of function
- **32KHz – suitable for low power/battery application**
  - with lower power consumption
  - WAIT mode down to 1.8µA; STOP mode 0.7µA
  - real time clock (RTC)
- **multiple serial interfaces**
  - SPI – I2C – UART – LIN

- **M16C platform – code compatibel low to high**
- **More performance in 8bit applications**
- **Best EMI performance**
- **Provide best C code efficiency**
- **Reduce system cost not only MCU cost**

- **other high performance features**
  - 2 banks of CPU register -> excellent for Bank switching (better code & performance)
  - up to 12 channels of 10-bit ADC (3.3µs conversion time)
  - AD converter and DA converter on one chip
  - excellent interrupt handling with selectable different priority levels
  - to eliminate noise, inputs with dedicated **“Digital filters”**.
- **Failsafe functionalities**
  - read out protection via ID code
  - protection of SFR – to avoid overwriting of important MCU register
  - watchdog timer with independet clock source
  - oscillator stop detection
- **High Reliability Flash memory**

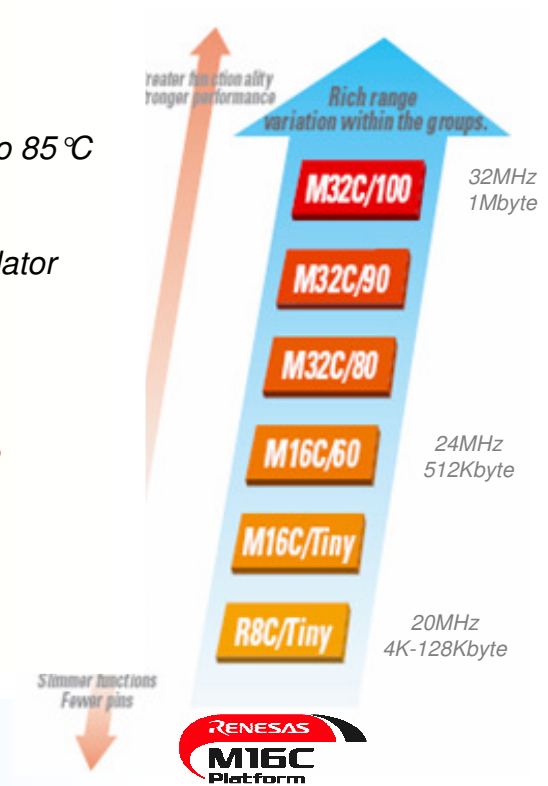



# R8C/2A & 2B

# Product Guide

## Package information

JEITA Package Code	RENESAS Code	Previous Code	MASS[Typ.]
P-LQFP64-10x10-0.50	PLQP0064KB-A	64P6Q-A / FP-64K / FP-64KV	0.3g

NOTE)

1. DIMENSIONS \*\*1\* AND \*\*2\* DO NOT INCLUDE MOLD FLASH.
2. DIMENSION \*\*3\* DOES NOT INCLUDE TRIM OFFSET.

Reference Symbol	Dimension in Millimeters		
	Min	Nom	Max
D	9.9	10.0	10.1
E	9.9	10.0	10.1
A <sub>2</sub>	—	1.4	—
H <sub>D</sub>	11.8	12.0	12.2
H <sub>E</sub>	11.8	12.0	12.2
A	—	—	1.7
A <sub>1</sub>	0.05	0.1	0.15
b <sub>p</sub>	0.15	0.20	0.25
b <sub>1</sub>	—	0.18	—
c	0.09	0.145	0.20
c <sub>1</sub>	—	0.125	—
θ	0°	—	8°
Ⓢ	—	0.5	—
x	—	—	0.08
y	—	—	0.08
Z <sub>D</sub>	—	1.25	—
Z <sub>E</sub>	—	1.25	—
L	0.35	0.5	0.65
L <sub>1</sub>	—	1.0	—

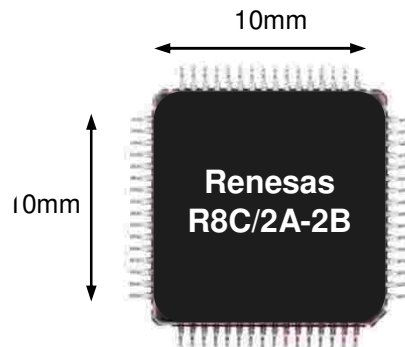

- **Packages**
  - pin 64 LQFP ( 10x 10 x 1.7mm)
  - 0.5mm pitch



# R8C/2A & 2B

## Package information

# Product Guide

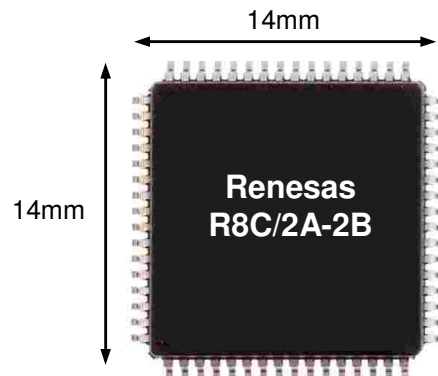
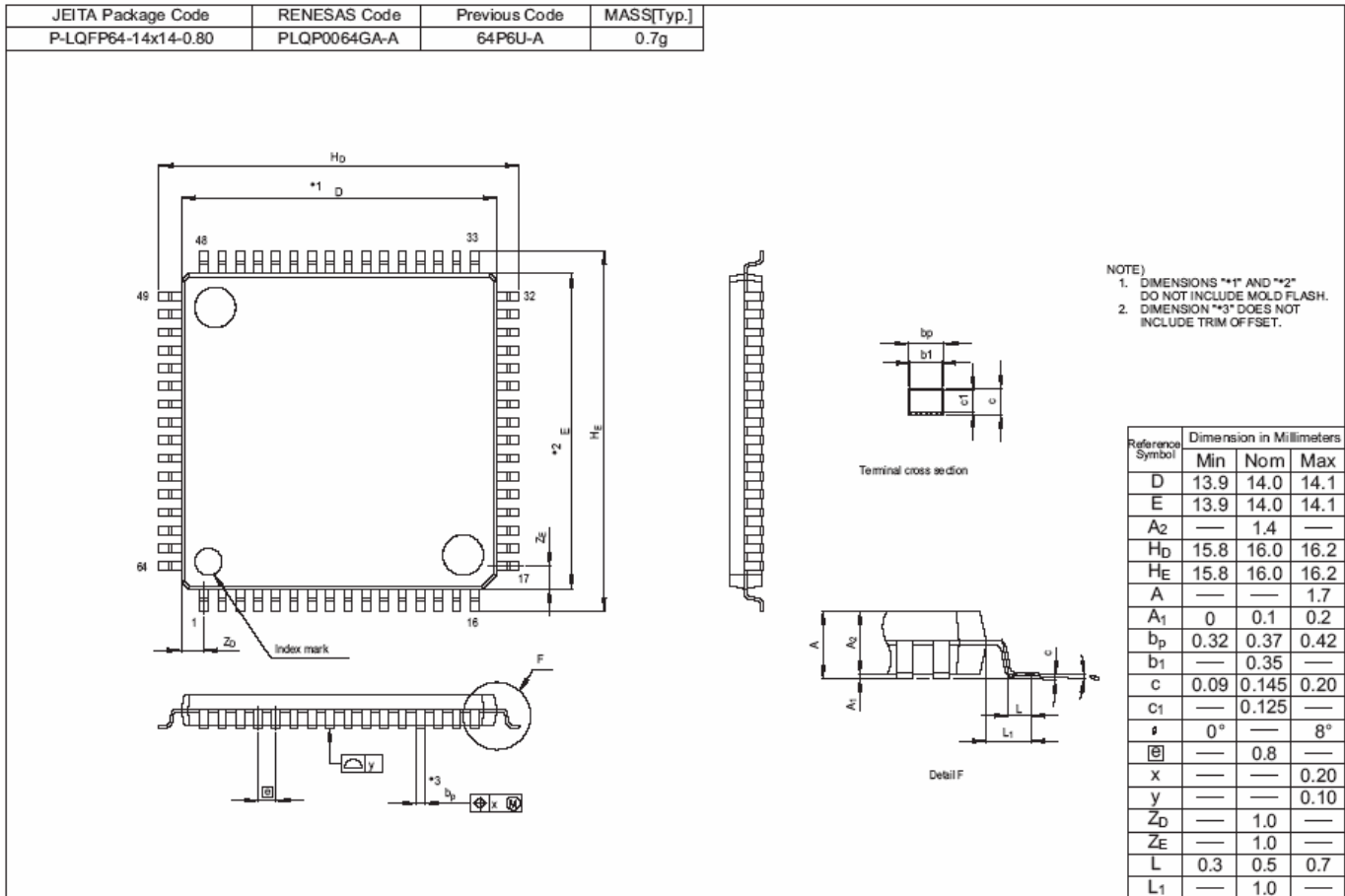

- **Packages**
  - pin 64 LQFP ( 14x 14 x 1.7mm)
  - 0.8mm pitch



# R8C/2A & 2B

# Tool Overview

Tool Type		Tool Name
<b>Software</b>		
C Compiler Including High-performance Embedded workshop ( HEW)		S32HEWNC30-1-6
Simulator Debugger		Supplied as part of compiler
Flash Development Toolkit		Free of charge download from web
<b>Hardware</b>		
Starter Kit RSKR8C2D		R0K5212D8S000BE (based on the 80pin R8C/2D)
On chip Debugging system E8A Emulator		R0E00008AKCE00
Compact emulator System (CPE system) (Package 1)	<b>CPE package 1</b>	R0E5212BACPE00 (inc. CPE emulator & converter board)
	CPE emulator (only)	R0E521000CPE00
	Converter boards (only)	a) R0E5212BACFG00 (*1) 64-pin 0.8mm-pitch LQFP
Compact emulator System (CPE system) (Package 2)	<b>CPE package 2</b>	R0E5212BACPE10 (inc. CPE emulator & converter board)
	CPE emulator (only)	R0E521000CPE00 (*2)
	Converter boards (only)	a) R0E5212BACFK00(*1) 64-pin 0.5mm-pitch LQFP
Full-spec Emulator system (Package 1)	<b>Emulator</b>	<b>PC7501</b>
	<b>Emulation Probe Package 1</b>	R0E5212BAEPB00 Inc. Emulator probe & converter board
	Emulation probe (only)	R0E521000EPB00 (*2)
	Converter board (only)	R0E5212BACFG00 (*1) 64-pin 0.8mm-pitch LQFP
Full-spec Emulator system (Package 2)	<b>Emulator</b>	<b>PC7501</b>
	<b>Emulation Probe Package 2</b>	R0E5212BAEPB10 Inc. Emulator probe & converter board
	Emulation probe (only)	R0E521000EPB00 (*2)
	Converter board (only)	R0E5212BACFK00 (*1) 64-pin 0.8mm-pitch LQFP

(\*1) the converter board is the same for the Full-spec Emulator and the CPE

(\*2) Note on debugging the 128 Kbyte ROM products The maximum ROM capacity supported by this Emulator Probe and CPE is 112 Kbytes. It's not possible to debug programs larger than 112 Kbytes (20000h—23FFFh).



# R8C/2A & 2B

# Tool Starterkit

Starterkit „Easy to Start“ – by using the 80pin RSK R8C/2D *Available*



**RSK R8C/2D:**

**Order number:**  
**R0K5212D8S000BE**

## R8C Starter Kit (RSK)

- The kit includes:
- CPU board with target microcontroller
- LCD panel for user/diagnostic interaction
- E8 On Chip Debugger
- Trial C compiler and IDE
- Tutorial session
- Sample peripheral driver code

**Note:** This RSK R8C/2D kit is based on the 80pin R8C/2D device, and has – compared to the 64pin R8C/2A-2B - more IO pins and AD converters with additional scan function. The features on the 80pin are SW compatible to the R8C/2A-2D.

## E8A Emulator – on chip debugger



*One tool to flash & debug  
Single line to flash & debug*

**E8A Emulator:**

**Order number:**  
**R0E00008AKCE00**

The E8A is a low cost on-chip tool software and hardware tool to debug and flash all R8C devices:

R8C/11&13; R8C/18-19; R8C/1A-1B; R8C/20-23; R8C/24-25; R8C/26-27; R8C/28-29; R8C/2A-2B, R8C/2C-2D

### • Others

- USB interface
- Hardware break (4 points)
- Software break (max. 255 points)
- Can perform as on-board programming tool using the write mode.
- Power supply:USB bus powered
- Supports power supply function to target (5V/3V switchable)

### • Small Body size:

- 92mm x 42mm x 15mm

### • Realtime debugging:

- Operates in the highest frequency of CPU
- High transfer speed





# R8C/2A & 2B

# Tool CPE

## Compact Emulator – low cost emulator

**Note:** Please see the debugging note (\*2) on page 7

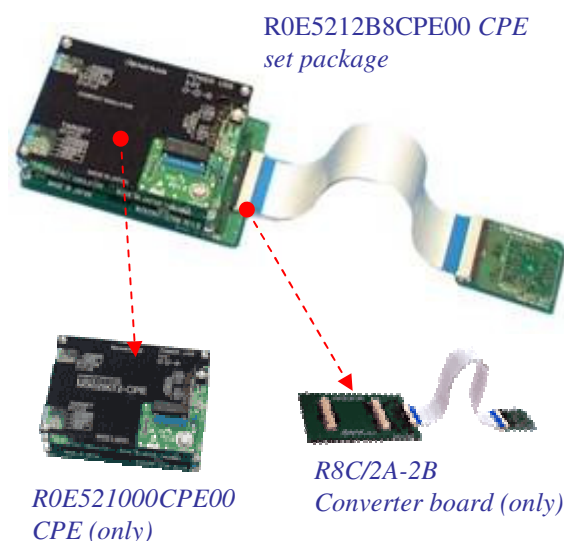

**Order number:**  
**R8C/2B set package:** Package 1) R0E5212BACPE00  
 Package 2) R0E5212BACPE10  
 (Inc. Compact emulator + R8C/2A-2B converter board)

**Available alone:**  
**Compact emulator (only):** R0E521000CPE00

**Convert boards (only):**  
 a) Board 0.8mm pitch: R0E5212BACFG00  
 MCU package: PLQP0064GA-A  
 (64-pin 0.8mm-pitch LQFP)  
 b) Board 0.5mm pitch: R0E5212BACFK00  
 MCU package: PLQP0064KP-A  
 (64-pin 0.5mm-pitch LQFP)

**From more information:** [www.eu.renesas.com/cpe](http://www.eu.renesas.com/cpe)

The Compact Emulator is supports the R8C/Tiny Series  
 R8C/11, R8C/13 Groups  
 R8C/18, R8C/19, R8C/1A, R8C/1B Groups  
 R8C/20-23 ; R8C/24-25; R8C/26-27; R8C/28-29; R8C/2A-2B; R8C/2C-2D Group

Basic debugging function	Download, S/W break (64 points), Program execution/stop (allows free-run execution and execution supporting S/W breaks) , Memory reference/setting (reference/setting C-variables, run-time execution) , Register reference/setting, Disassemble display, C-level debugging, etc.	
Real-time tracing	Trace range	64K cycles
	Trace data	20-bit address, 16-bit data, 12-bit MCU status
	Trace modes	5 modes (Break/Before/About/After/Full)
Real-time RAM monitor	Range	1024 bytes (256 bytes x 4 blocks)
	Results	Data, Latest access attribute (Read/Write/Non-accessed)
Hardware break function	2 points (Address break, R/W break, 255 pass counts) *1	
Execution time measurement	Time between program start to stop is measurable.	

Available at affordable prices though, the Renesas' the Compact Emulator has all the functions needed for the code development, such as real-time trace and hardware breaks. Easy-to-use GUI (Graphical User Interface) and advanced debugging features improve the debugging efficiency of applications on your target system. The emulator main unit comes in a significantly reduced size, compared with conventional emulator systems. This product package includes not only an emulator main unit and connectors but also the limited cross tools, so, you can program and debug your applications as soon as you open the package. The compact emulator R0E521000CPE00 can be connected to the user system by equipping with a converter board for your target MCU. (See above.) For your target MCU, we also provide set packages that include the compact emulator and a converter board you will need.



# R8C/2A & 2B

# Tool High End

## PC7501 Emulator – high end emulator

**Note:** Please see the debugging note (\*2) on page 7

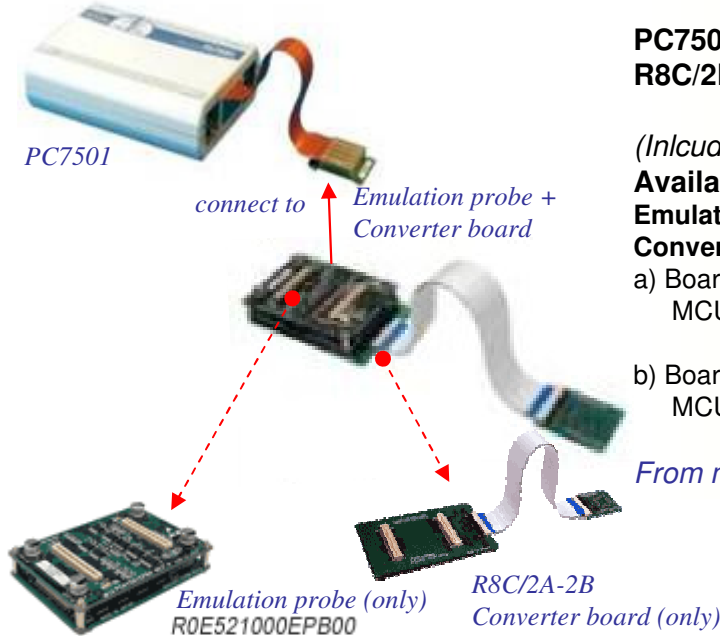

**Order number:**

**PC7501 Emulator:** **PC7501**  
**R8C/2B set package:** Package 1) R0E5212BAEPB00  
 Package 2) R0E5212BAEPB10  
 (Includes Emulator probe + R8C/2A-2B converter board)

**Available alone:**

**Emulator probe (only):** R0E521000CPE00  
**Convert boards (only):**  
 a) Board 0.8mm pitch: R0E5212BACFG00  
 MCU package: PLQP0064GA-A  
 (64-pin 0.8mm-pitch LQFP)  
 b) Board 0.5mm pitch: R0E5212BACFK00  
 MCU package: PLQP0064KP-A  
 (64-pin 0.5mm-pitch LQFP)

From more information: [www.eu.renesas.com/pc7501](http://www.eu.renesas.com/pc7501)

The Emulator is supports the R8C/Tiny Series  
 R8C/11, R8C/13 Groups  
 R8C/18, R8C/19, R8C/1A, R8C/1B Groups  
 R8C/20-23 ; R8C/24-25; R8C/26-27; R8C/28-29;  
 R8C/2A-2B; R8C/2C-2D Group

Software break	64 points
Hardware break	16 points * <sup>3</sup> (Execution address/Bus detection/Interrupt/External trigger signal)
Hardware break condition	AND/OR/AND (same time) /State transition • Pass counts : 255 times
Exception event detection	Access protect
Real-time trace	256K cycles • Trace data : Bus, External trigger, and Time stamp • Five trace modes : Break/Before/About/After/Full • Can be recorded ON/OFF by events
Real-time RAM monitor	4,096 bytes (256 bytes × 16 blocks) • Data / Last access result
Execution time measurement	Execution time between program start to stop. • Maximum/minimum/average execution time and pass count of specified four zones. • Count clock : Equal to MCU Clock or 16MHz
C0 coverage	8,192K bytes (256K bytes × 32 blocks)
External Trigger Input / Event Output	External trigger input (MCU-dependent-voltage CMOS level × 8) or Event output (Break × 1, event × 7)

The PC7501 emulator has full bus trace and is available for in-circuit emulation in system designed around the M16C Platform of processors. This compact unit is capable of emulation up to 66MHz (i.e., available at over 20MHz) and has many other enhancements compared to the Compact Emulator. This emulator is for common use in some leading-edge MCU of M16C Family. User-replaceable emulation probes (sold separately) and accessories such as connectors (sold separately) accommodate variations between different MCUs.



# R8C/2A & 2B

# Tool CPE socket

## PC7501 & Compact Emulator – Connection to User System

### How to connect your target board – for 64pin 0.5mm pitch ?

- a) Compact Emulator (CPE) - R0E521000CPE00
- b) PC7501 - Emulation probe - R0E521000EPB00

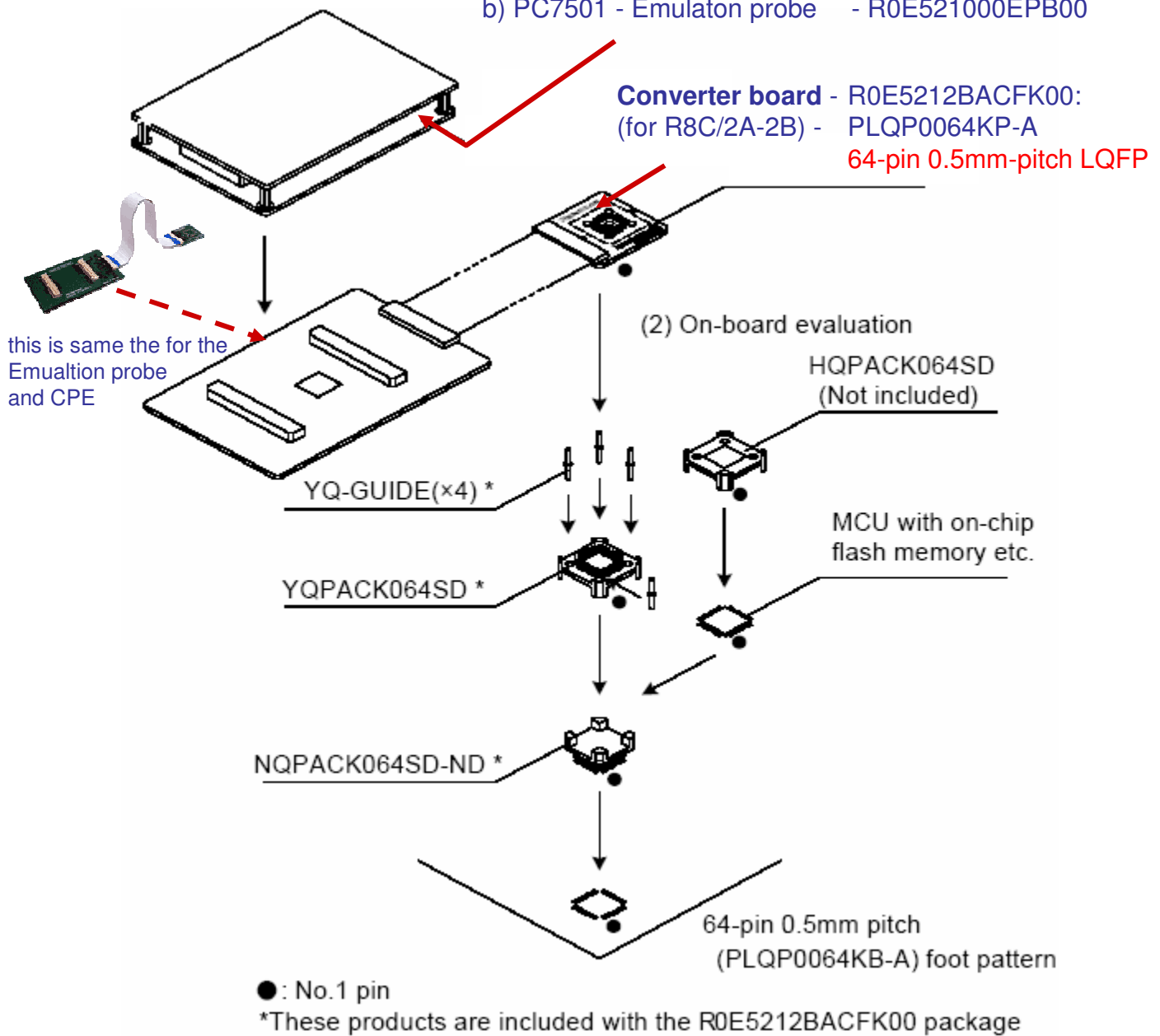



# R8C/2A & 2B

# Tool CPE socket

## PC7501 & Compact Emulator – Connection to User System

### How to connect your target board – for 64pin 0.8mm pitch ?

- a) Compact Emulator (CPE) - R0E521000CPE00
- b) PC7501 - Emulation probe - R0E521000EPB00

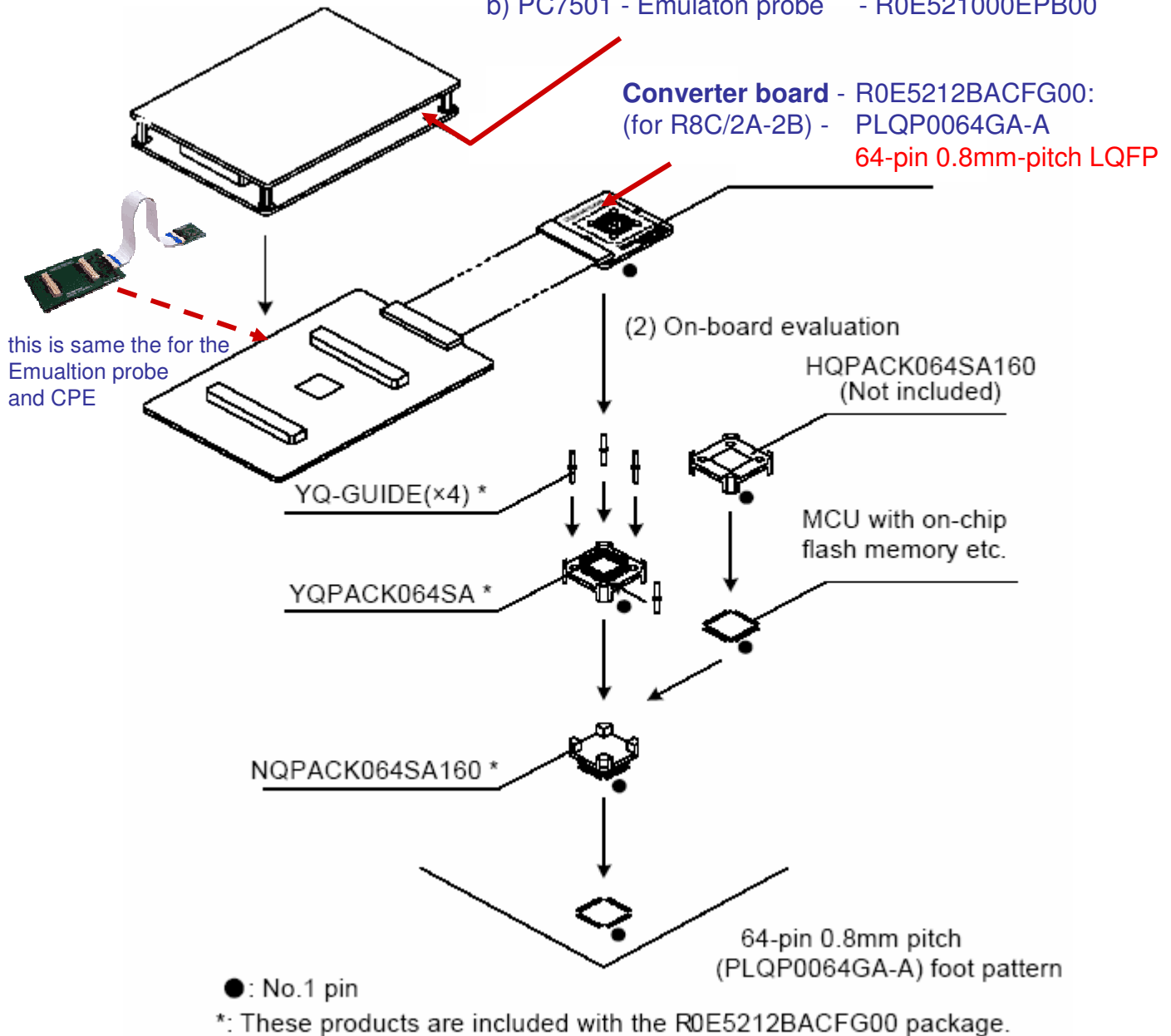



# R8C/2A & 2B

# Tool HEW

## R8C/Tiny Software



HEW:

Order number:  
**S32HEWNC30-x-y**  
(for x, y pls. see below table)

Include compiler: M3T-NC30WA  
From more information: [www.eu.renesas.com/nc30wa](http://www.eu.renesas.com/nc30wa)  
[www.eu.renesas.com/hew](http://www.eu.renesas.com/hew)

High Performance  
Embedded  
Workshop  
& Renesas NC30 - Compiler

**Download Software from web**  
**Free of charge - HEW + compiler (no support)**  
- 60 days without limit  
- after 60 days - **64K code size limitation**

All existing M32C, M16C & R8C debug platforms such as PC7501, Compact Emulators (CPE) and KD30 ROM monitors have been integrated into the HEW debugger. All features of the PD30/PD308 debuggers have been migrated into HEW 4.

### C Compiler Package - M3T-NC30WA (included NC30 and AS30)

The C Compiler Package M3T-NC30WA V.5.40 Release 00A and higher supports for the R8C/1x and R8C/2x devices

## HEW 4 is available in 2 different license types Node locked and network licenses available

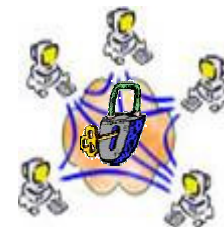

Number of users	License type	Support Period in months	R8C & M16C
1	Node locked	6	S32HEWNC30-1-6
		18	S32HEWNC30-1-18
	Network	6	S32HEWNC30-N1-6
		18	S32HEWNC30-N1-18
5	Node locked	6	S32HEWNC30-5-6
		18	S32HEWNC30-5-18
	Network	6	S32HEWNC30-N5-6
		18	S32HEWNC30-N5-18

The network license allows more than one user access to the compiler but not at the same time. When a compiler is invoked, the HEW licence manager will allocate a license to the user. This license will remain with the user for a minimum of 30 minutes, but user can select longer periods.

Once a license has been allocated to a user he can disconnect from the network (e.g. laptop) and continue to use the license for the allocated time



# R8C/2A & 2B E8A & FDT Tool

## How to flash R8C/Tiny ?

Use E8A Emulator *one Tool* to flash & debug on *ONE WIRE* (via Mode pin)

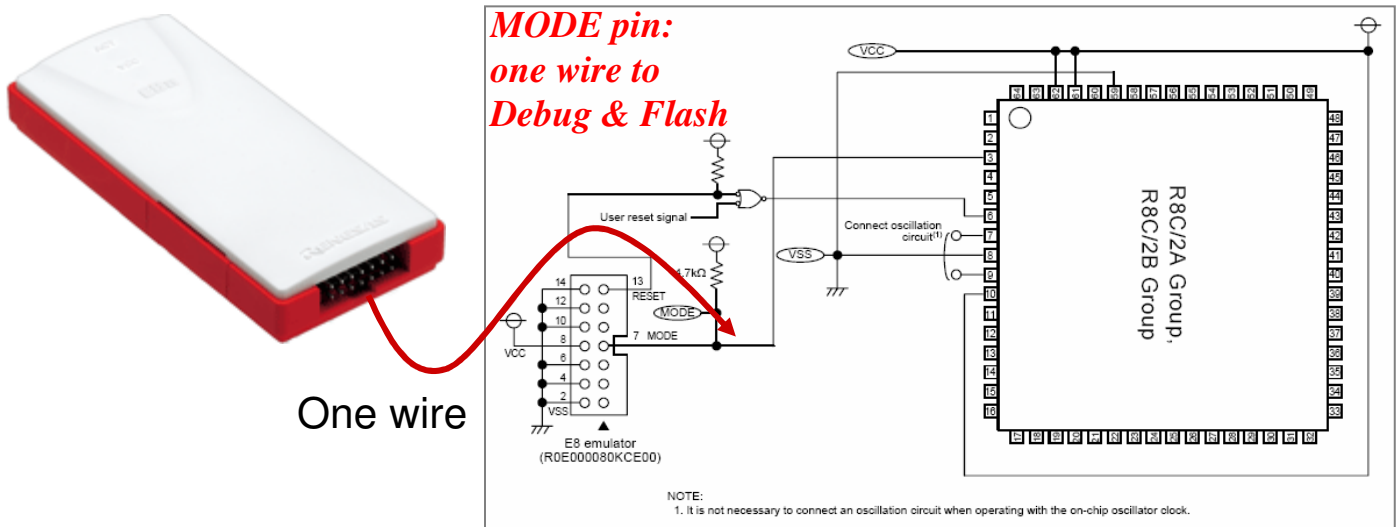

## FDT - Flash Development Toolkit

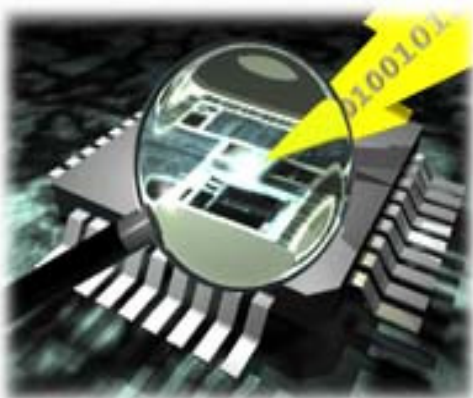

**FDT Software:**  
*Flash Development Toolkit*  
from more information:

**Order number:**  
**free of charge download**

[www.eu.renesas.com/fdt](http://www.eu.renesas.com/fdt)

The FDT supports the R8C/Tiny Series  
SuperH RISC engine family  
H8SX family  
H8S family  
H8 family  
M16C & R8C family  
740 family

Renesas Flash Development Toolkit is a dedicated flash programming tool for Renesas microcomputers, which offers a sophisticated and easy-to-use Graphical User Interface. Moreover, when it is used with High-performance Embedded Workshop, it allows user who involved in development of the embedded application software adopting Renesas F-ZTAT microcomputers to advance the development under one common environment.



# R8C/2A & 2B

# Others Information

- **R8C Product information**

- Datasheets
- Application Notes
- Tool-Information

[http://eu.renesas.com/fmwk.jsp?cnt=r8ctiny\\_series\\_landing.jsp&fp=/products/mpumcu/m16c\\_family/r8c\\_tiny\\_series/](http://eu.renesas.com/fmwk.jsp?cnt=r8ctiny_series_landing.jsp&fp=/products/mpumcu/m16c_family/r8c_tiny_series/)



- **Easy to learn more about R8C...**

Renesas Interactive is an **e-learning facility** for all Renesas devices and development tools

[www.renesasinteractive.com](http://www.renesasinteractive.com)



- **Internet:**

[www.microchooser.com](http://www.microchooser.com)

MCU and Tool browser



## Renesas Technology

the world's number 1\* provider of microcontrollers, takes you where your imagination lead

[www.eu.renesas.com](http://www.eu.renesas.com)

# RENESAS

Everywhere you imagine.



## Roadmap

**8KB - 16KB**  
RAM: 376B - 1kB

**R8C/28-29**

20pin

**8KB - 32KB**  
RAM: 512B - 1kB

**R8C/26-27**

32pin

**32KB - 64KB**  
RAM: 512B - 3kB

**R8C/22-23**

48pin

**16KB - 64KB**  
RAM: 512B-3kB

**R8C/24-25**

52pin

**48KB - 128KB**  
RAM: 2.5K-7.5kB

**R8C/2A-2B**

64pin

**48k - 128kB**  
RAM: 2.5K-7.5kB

**R8C/2C-2D**

80pin